

**ATTENTION!!!**  
Pour éviter d'abîmer vos pièces de bois, il faut les pré-percer avant de visser.

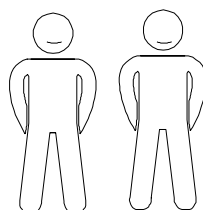
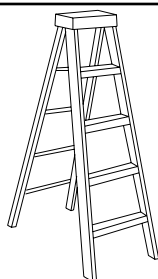

AL 2020.02 N

Code EAN : 3760161070539

Colis n° :

(à rappeler impérativement pour toute demande SAV)

PLAN DE SOUBASSEMENT

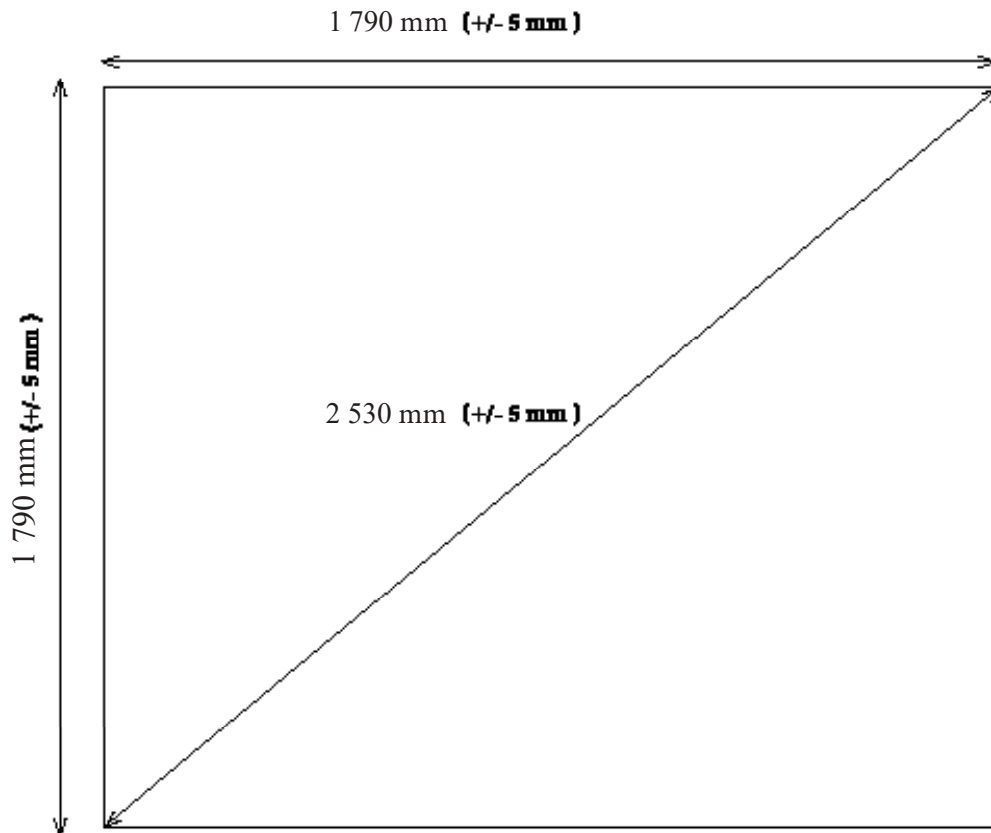

Les dimensions données sur le plan de soubassement sont les dimensions de la dalle béton à réaliser sur un sol parfaitement plat sans aucun autre objet extérieur type mur, clôture ou arbre dans l'entourage de la dalle. Si le produit est implanté près d'un mur, d'une haie ou d'un arbre il est nécessaire de l'éloigner des éléments extérieurs afin de pouvoir facilement le monter et l'entretenir. Nous nous dégageons de toute responsabilité en cas de mauvaise interprétation des dimensions de la dalle.

Le dimensioni del piano di base sono le dimensioni della soletta di cemento da realizzare su un terreno perfettamente piatto, senza alcun altro oggetto esterno, come un muro, una recinzione o un albero in prossimità delle soletta. Se il prodotto è installato vicino ad una parete, un recinto o un albero, è necessario distanziarlo adeguatamente, in modo da poterlo facilmente montare e farne la manutenzione. Non ci assumiamo alcuna responsabilità per l'errata interpretazione delle dimensioni delle lastra.

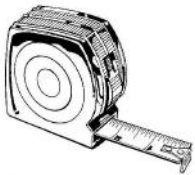













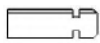



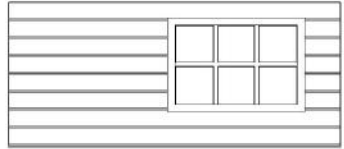

Tolérances à respecter (selon DTU 31.2):

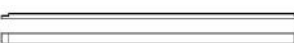
- longueur et largeur: + 0,01m;
- équerrage: +0,01m mesuré sur 10m;
- arase: +0,01m sur une longueur de 10 mètres linéaires alignés ou non et de + 2mm par mètre linéaire;
- rectitude de bords en plan: +5mm .







# NOTICE DE MONTAGE AL 2020.02 N

Nous garantissons la fourniture des pièces détachées durant 2 ans à compter de l'achat du produit.  
Vérifier que vous avez bien toutes les pièces avant d'effectuer le montage

Demande SAV

Nr.	Qte	Dessin pièce	Ref	Dimensions	Observation	Qte
1.	2		I20.2.1950	1950* 55* 20		
2.	32		L20.2.1950	1950*108* 20		
3.	16		L20.2.1950	1950*108* 20		
4.	32		L20.1.535	535*108* 20		
5.	2		R150.90	150* 90* 20		
6.	4		DSF1130.90	1130* 90* 20		
7.	1		TLD1690.20	1690* 80* 60		
8.	1		TLS1690.20	1690* 80* 60		
9.	1		UD1690.40	1690* 800* 40		
10.	2		F1950.300	1950*300* 20		
11.	4		GL1950.20	1950* 70* 40		
12.	2		LS28.2.1950	1950* 108* 40		
13.	1		EST880.40	880* 40* 20		
14.	2		ELT200.70	200* 70* 20		
15a	4		OND664.860	664* 860* 30		
15b	2		OND664.430	664* 430* 30		
16a	4		OND498.860	498* 860* 30		
16b	2		OND498.430	498* 430* 30		
17.	2 1		FON1000.490 FON500.490	1000*490* 30 500*490* 30		
18.	60		Clous ond			

**NOTICE DE MONTAGE**  
**AL 2020.02 N**

Nr.	Qte	Dessin pièce	Ref	Dimensions	Observation	Qte
19.	8		ClouL80			
20.	30		ClouL16			
21.	37		Vis3.5*35			
22.	32		Vis4.5*45			
23.	1		Loquet			
24.	3		Pentures BG150			

**A compléter impérativement pour toute demande SAV et à envoyer par mail à sav@foresta.fr + photo des pièces abîmées (To be completed imperatively + Photo of damaged parts)**

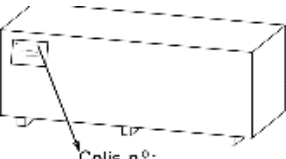
	AL 2020.02 N <u>Colis(package) n° :</u> .....	MAGASIN (STORE)	
		NOM (NAME) CLIENT	
		PRENOM(PRE.) CLIENT	
		N° de téléphone (PHONE)	

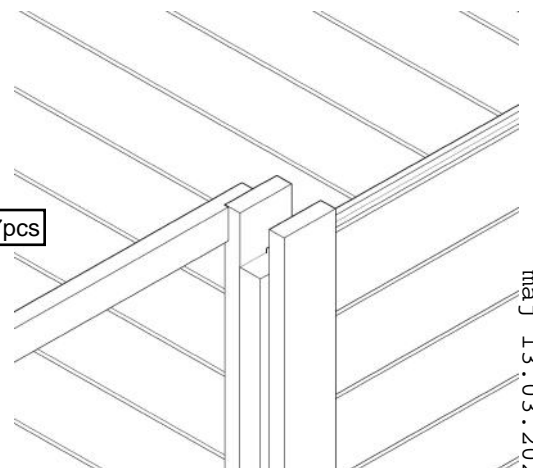
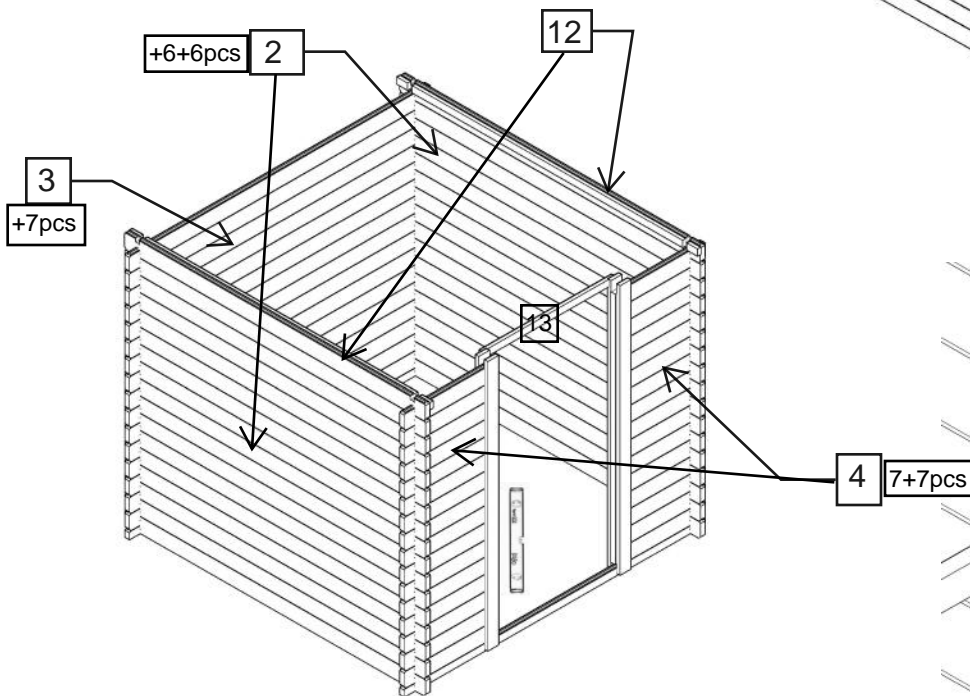
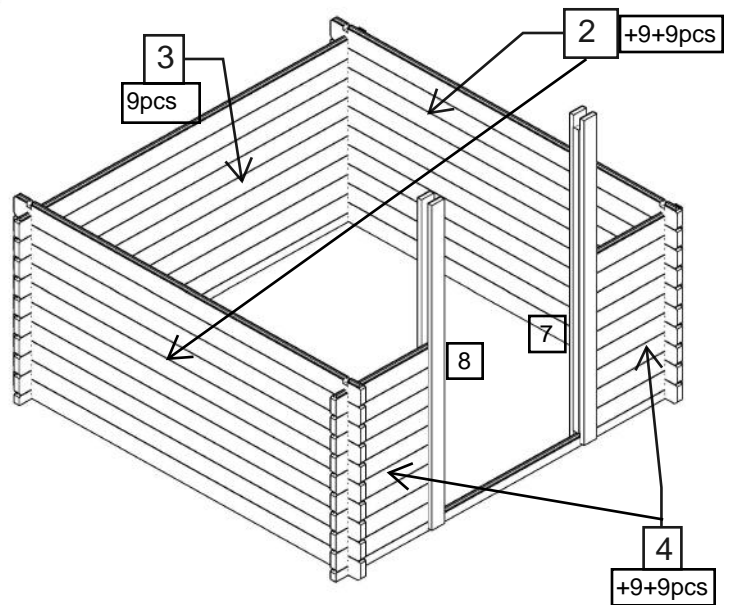
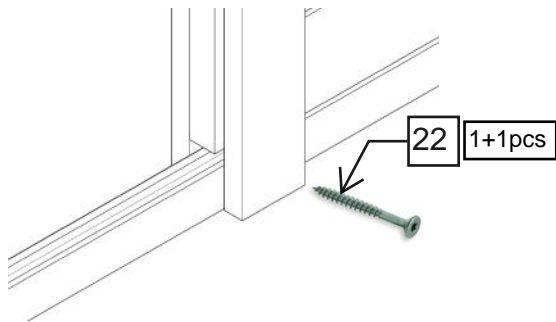
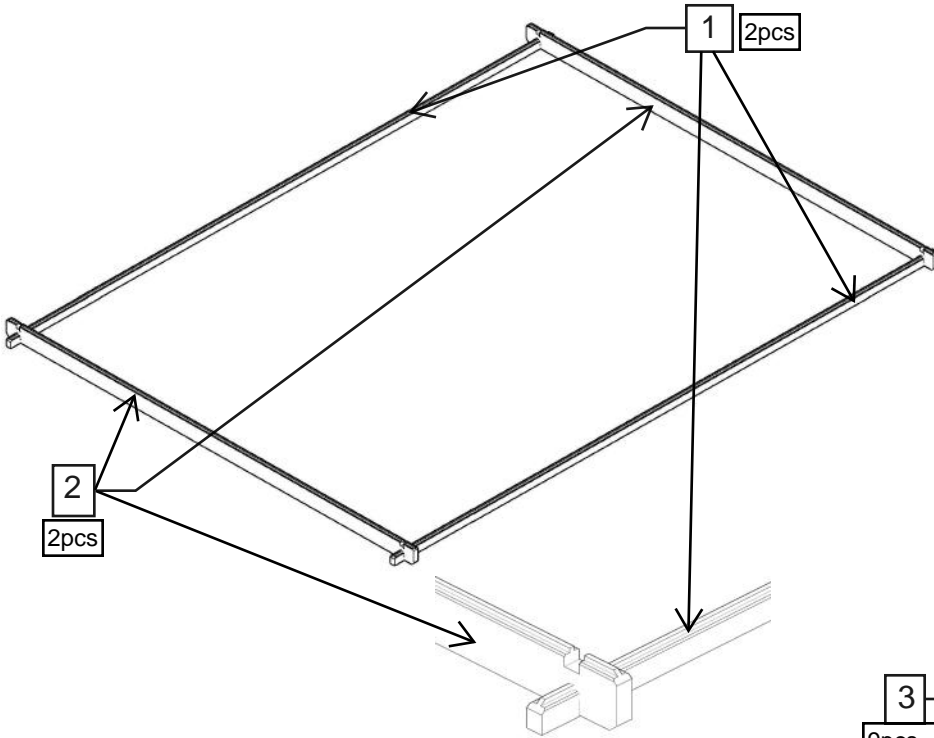

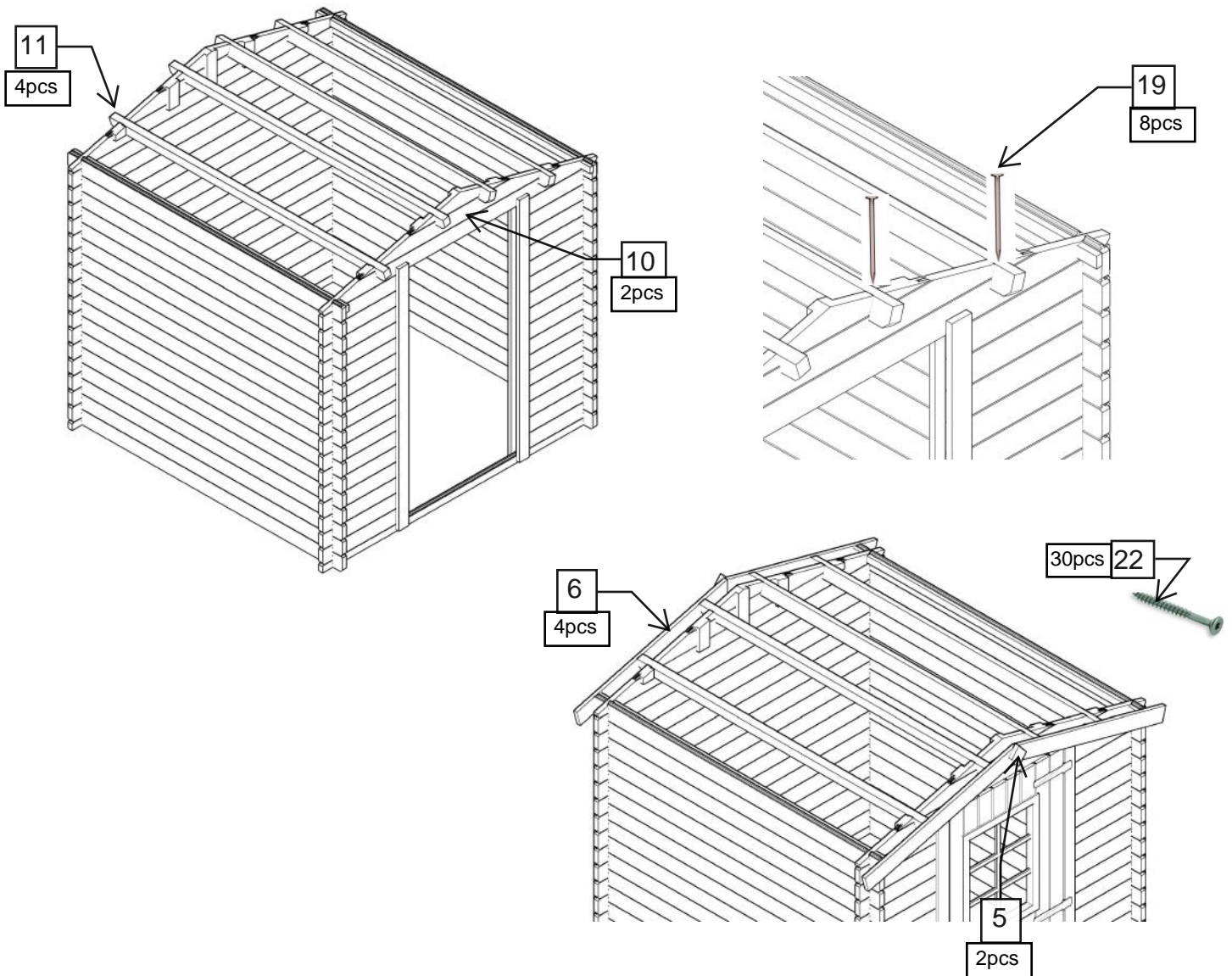

Installer les décorations n ° 6 puis commencer à positionner les plaques ondulées en commençant par l'avant et l'arrière en fixant les plaques sur les décorations n ° 6 avec des clous n ° 20.

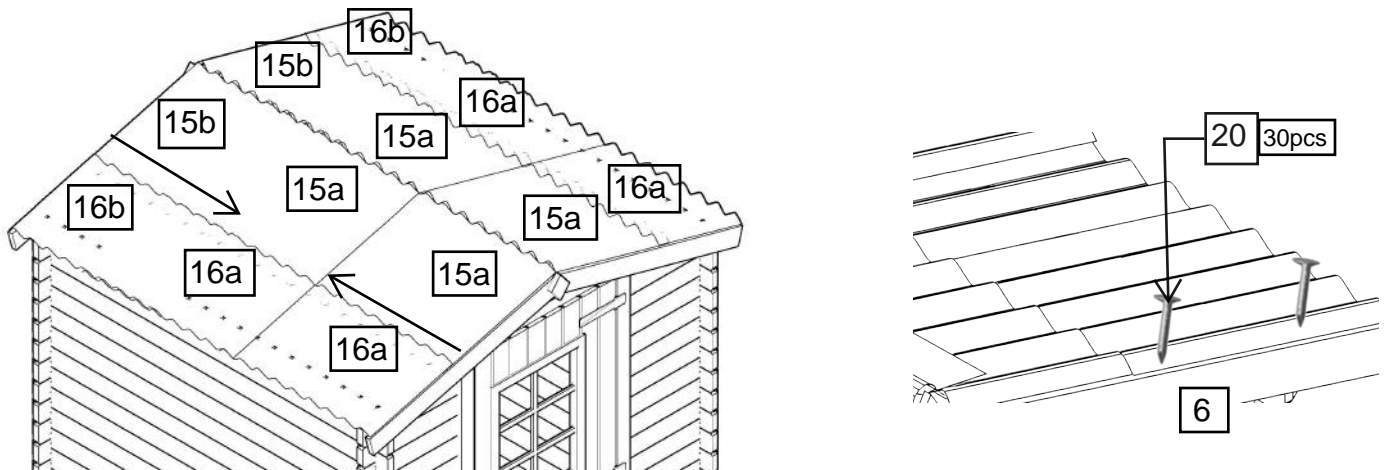

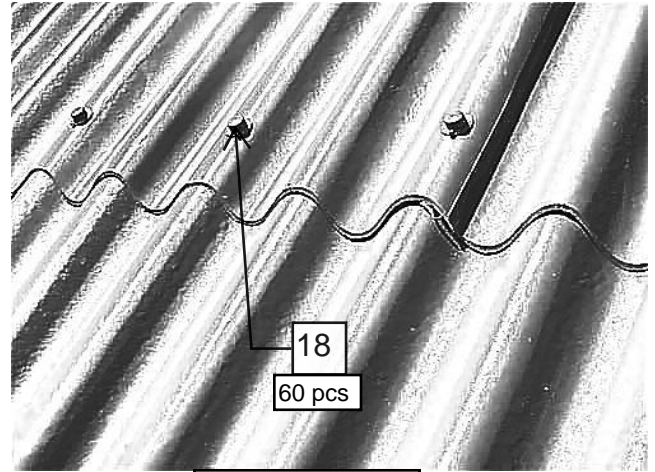

Fixer les clous une  
ondulation sur deux!

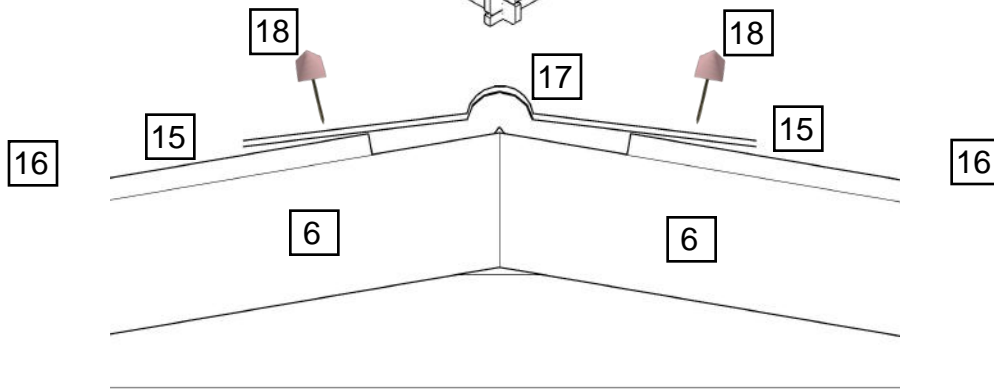
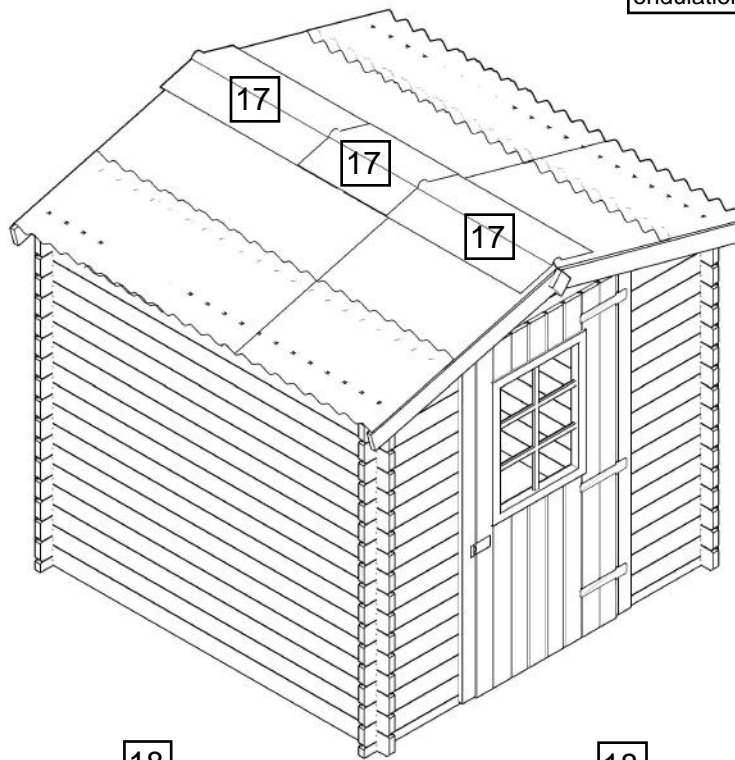

**FIXATION CADRE PORTE**

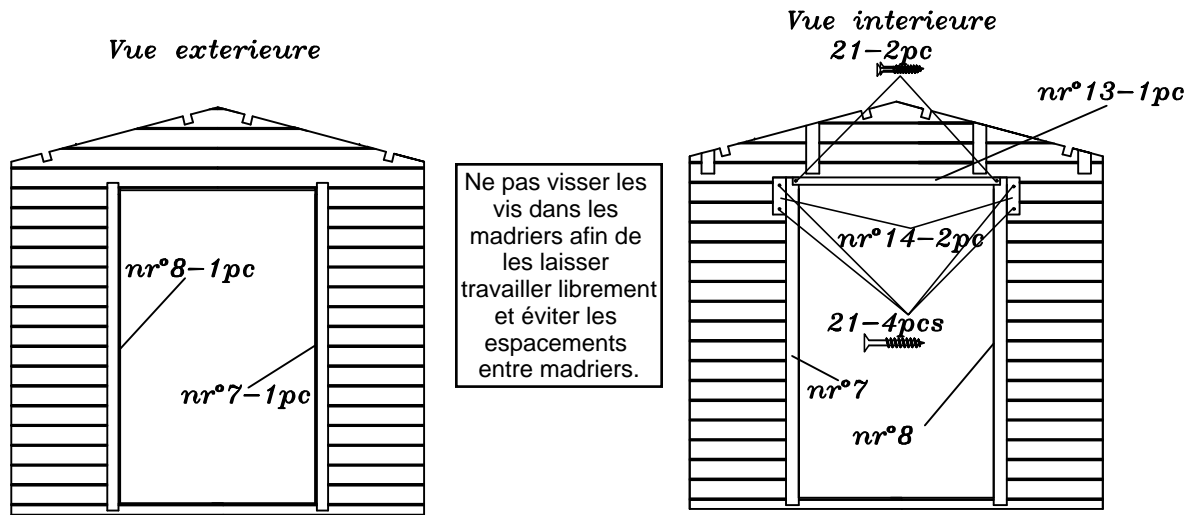

**FIXATION QUINCAILLERIE ET DECORATIONS PORTE**

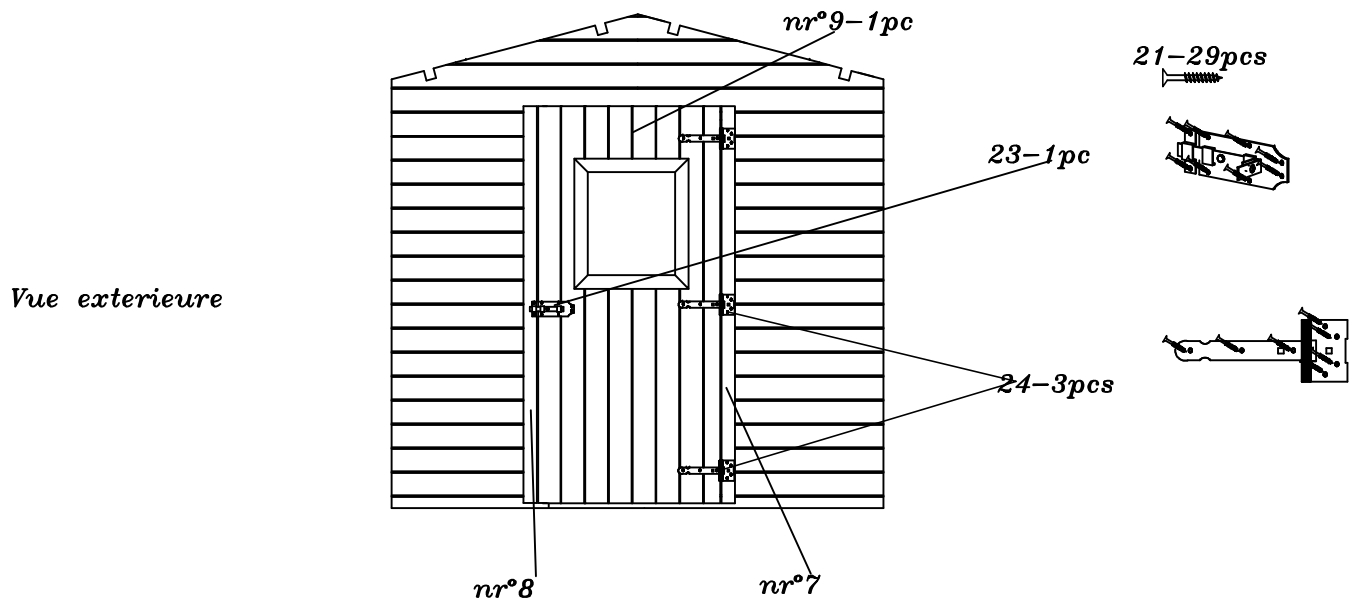



Paroi facade, vue de l'exterieur

Nr.	Qte.	Dimensions (mm)
1	1	1950 x 55 x 20
4	32	535 x 108 x 20
10	1	1950 x 300 x 40
11	4	1950 x 70 x 40

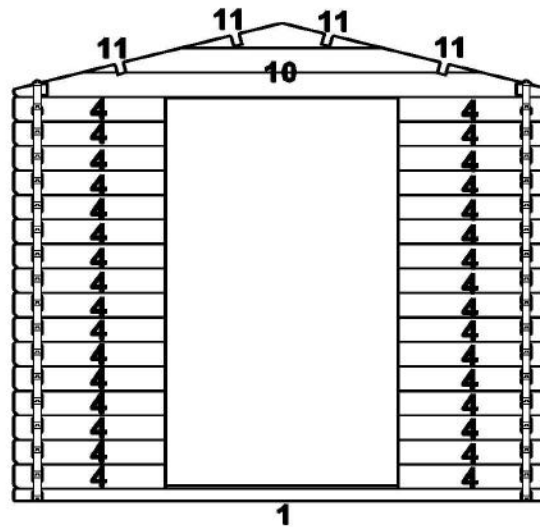

Paroi arriere, vue de l'exterieur

Nr.	Qte.	Dimensions (mm)
1	1	1950 x 55 x 20
3	16	1950 x 108 x 20
10	1	1950 x 300 x 40

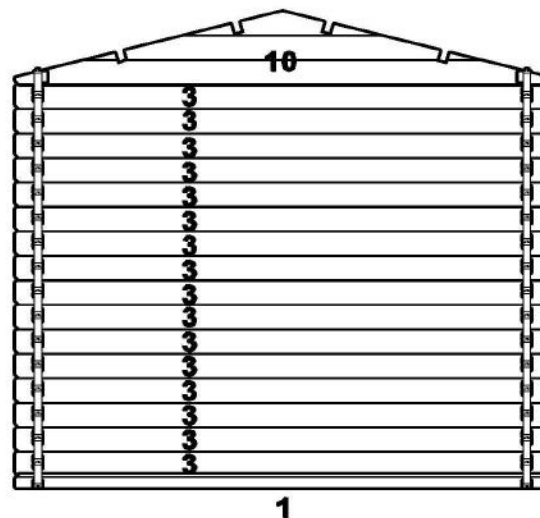

Paroi laterale gauche/droite, vue de l'exterieur

Nr.	Qte.	Dimensions (mm)
2	16+16	1950 x 108 x 20
12	1+1	1950 x 108 x 40

